

SPECIFICATIONS

Type	Double Sided 200mm Deep	
Where to fix	Freestanding	
LED Source	LED Modules SA 4161 Equivalent from SA-LED Australia	
Power Source	Suitable Power Supply from SA-LED Australia	
Dimension	Length	Any Size
	Height	Up to 1,500mm
	Deep	200mm
	<i>*Post deep : Max 150mm</i>	
Face	4.5mm Opal Acrylic	
Return	Aluminum Extrusion Bar - Mill (2B) Finish - White or Black - 2Pac Spray (Other colours)	
Back	ACM or Equivalent Material	
Cover Size	25 / 40 / 50mm Removable Angle Trim	

- Price do not include acrylic sheets.
- Price do not include packaging and delivery
- Artwork has to be provided by the client.
- Please make sure to include the original artwork files that is:
 - ✓ 1:1 Scale
 - ✓ 100% Vector (*.eps)
 - ✓ PDF File format (*.pdf)
 - ✓ CorelDRAW (*.cdr, *.dxf)

3D STRUCTURE

Front View

Return
Aluminum

Face
4.5mm
Opal Acrylic

LEDs
Installed on the fabricated
ACM or equivalent material

Post

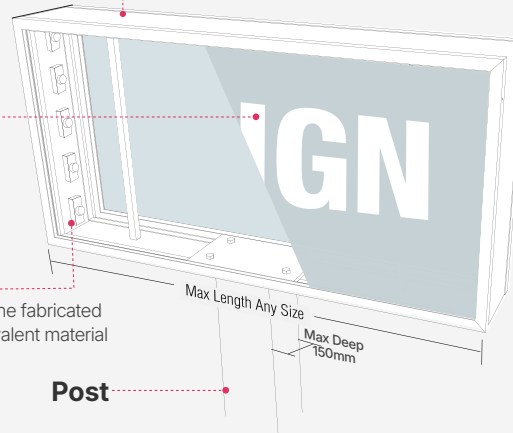

Side View

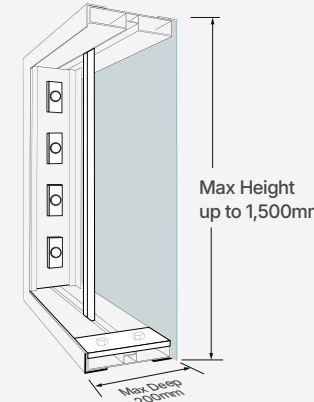

Side View : Freestanding

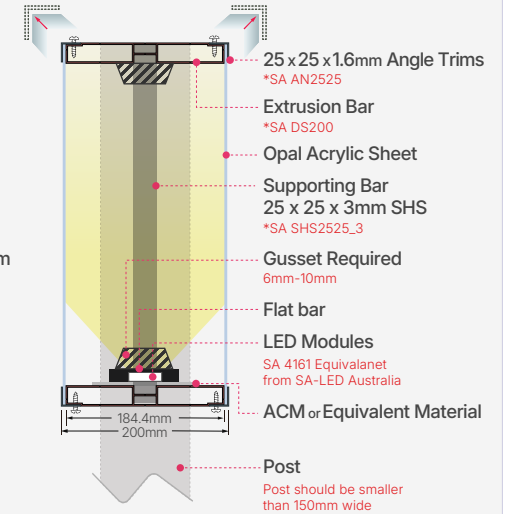

**All LED modules, power suppliers, extrusion bars, angle trims and other bars can be purchased in www.SA-LED.com*

INSTALLATION GUIDE

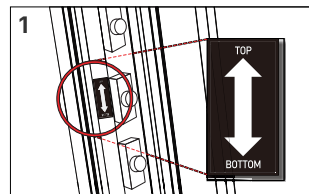

TOP & BOTTOM indicative sticker at the inside.

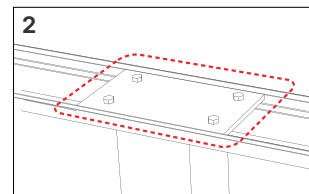

Weld an additional fixing base plate to the bottom of the frame to reinforce its structure.

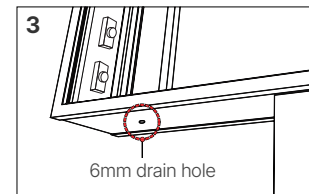

Predrilled 6mm drain holes on bottom.

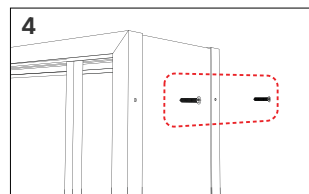

Remove screw from angle trims to insert acrylic.

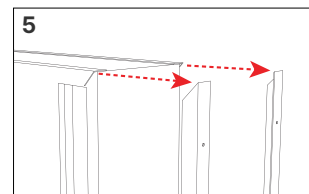

Remove angle trim from lightbox.

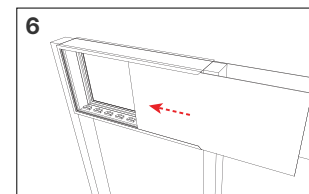

Insert acrylic face into body frame.

PROJECTS

